

visionaryTM
MAGELLAN DESIGNS

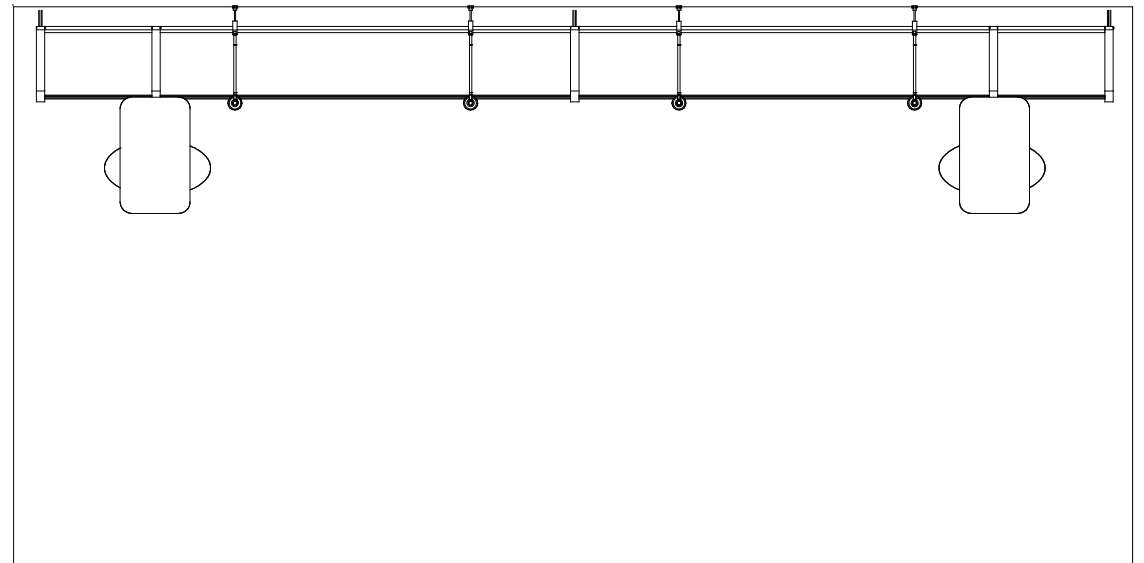
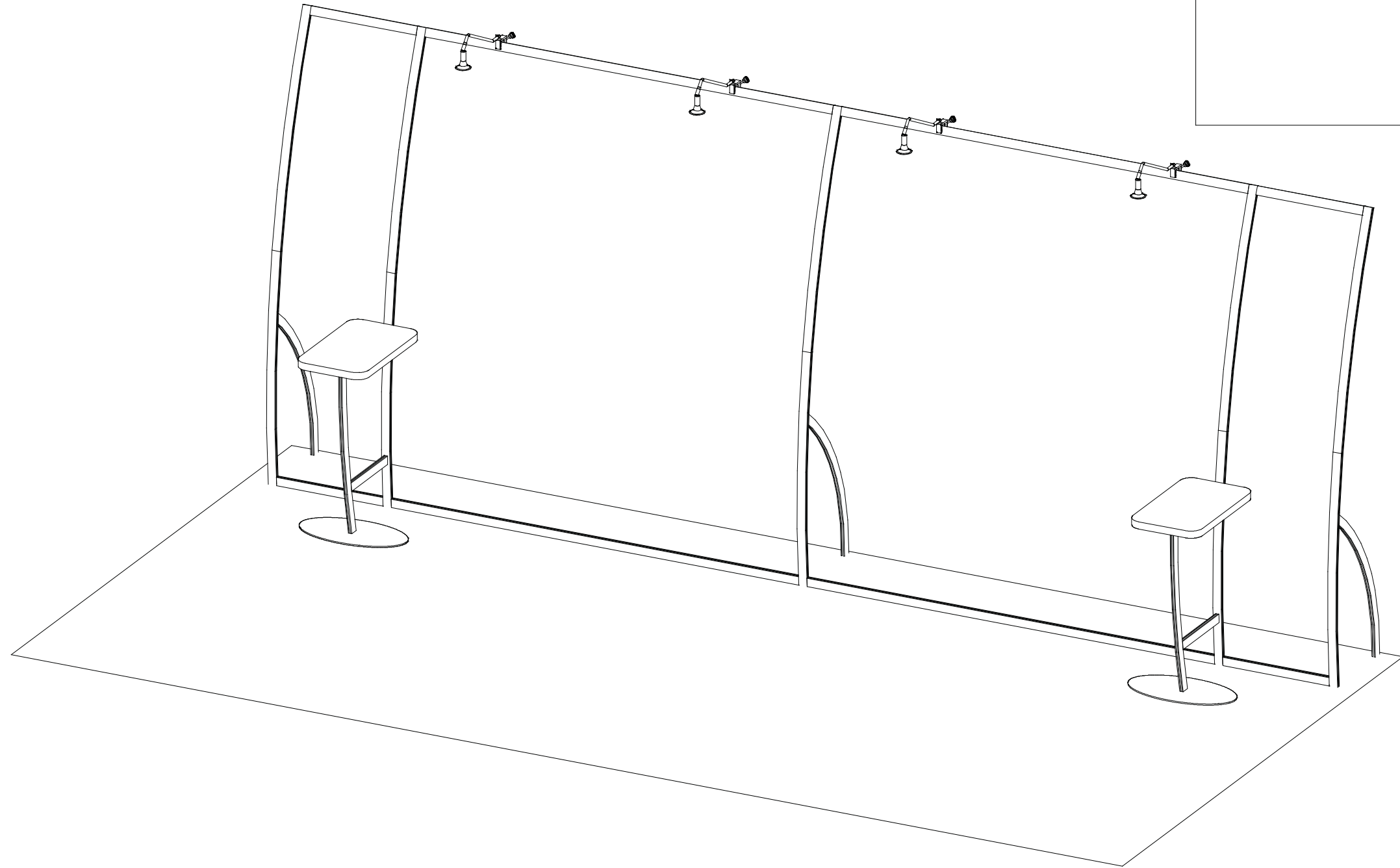

20'

10'

Plan View

WHEN DISASSEMBLING ALUMINUM EXTRUSION, TIGHTEN ALL SETSCREWS AND LOCKS TO PREVENT LOSS DURING SHIPPING

visionary™ IDESIGNS

Using Your Setup Instructions

The Visionary Designs Setup Instructions are created specifically for your configuration. They are laid out sequentially, including an exploded view of the entire display, and then a logical series of detailed steps to assemble the main structure and components. We encourage you to study the instructions **before** attempting to assemble your exhibit.

Each page reminds you to tighten the setscrews after disassembling your exhibit to prevent loss of the locks and setscrews (see below in RED). This is **VERY IMPORTANT**.

Cleaning and Packing Your Display

- 1) Use care when cleaning aluminum extrusion or acrylic inserts. Use only non-abrasive cleaners.
- 2) When cleaning laminate inserts or countertops, use mild cleansers and a soft material such as cotton.
- 3) Keep all display components away from extreme heat and long exposure to sunlight to avoid warping and fading.
- 4) Retain all packing material. It will make re-packing much easier and will reduce the likelihood of shipping damage.



The Tool

Most Visionary Designs exhibits can be assembled with the supplied Hex Key Tool. Occasionally, a flat head screwdriver may be required.



Typical Connection

Most horizontal extrusion connections have a patented expandable lock. This lock inserts into the groove of an opposing extrusion. Tightening the lock with the Hex Key Tool expands the lock and creates a strong positive connection.



Typical Connection (cont'd)



Detail B

Numbered Label

Each extrusion contains a numbered label which corresponds with setup instructions. The label is located within a groove of the extrusion (when possible). With Visionary Designs the labels contain Black numbers unless otherwise specified.



Detail C

Horizontal Inline Connection (remove only one setscrew)

Remove only (1) setscrew when disassembling. Replace setscrew in extrusion after assembling it. Before packing, replace setscrew in extrusion to avoid losing it.

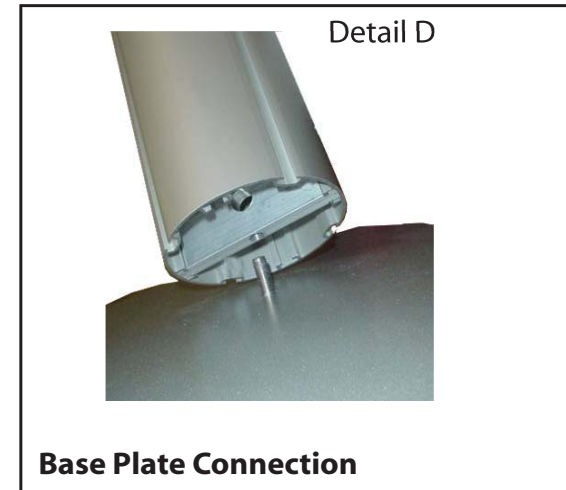

Detail D

Base Plate Connection

Attach base plate to round or square vertical extrusion using the bolt provided. Be careful not to strip the threads.

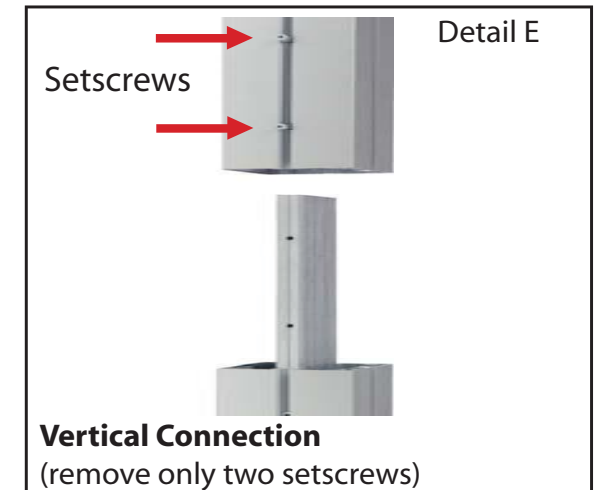

Detail E

Vertical Connection
(remove only two setscrews)

When vertical extrusions are packed in portable cases rather than crates or tubs, they must be broken down into smaller sections which then require assembly.

Remove only (2) setscrews when disassembling. Replace setscrews in extrusion after assembling it. Before packing, replace setscrews in extrusion to avoid losing them.

WHEN DISASSEMBLING ALUMINUM EXTRUSION, TIGHTEN ALL SETSCREWS AND LOCKS TO PREVENT LOSS DURING SHIPPING

866.652.2100

Part Number	Qty	Description
1	1	48.5" h Lower Curved Extrusion
2	1	48.5" h Upper Curved Extrusion
3	1	48.5" h Lower Curved Extrusion
4	1	48.5" h Upper Curved Extrusion
5	1	48.5" h Lower Curved Extrusion
6	1	48.5" h Upper Curved Extrusion
7	1	23" w Horizontal Extrusion
8	1	23" w Horizontal Extrusion
9a/9b	1/1	44" w Horizontal Extrusion
10a/10b	1/1	44" w Horizontal Extrusion
11	1	Backwall Support Leg Extrusion
12	1	Backwall Support Leg Extrusion

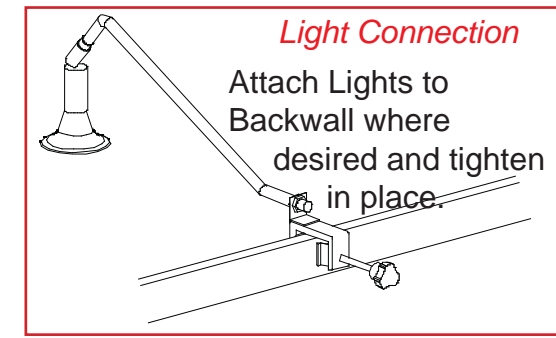

Steps

- 1) Connect backwall upper and lower verticals together [1 to 2, 3 to 4 and 5 to 6].
- 2) Connect horizontal extrusions together [9a to 9b and 10a to 10b].
- 3) Attach horizontal assemblies [7 and 8] between vertical assemblies [1/2 and 3/4].
- 4) Attach horizontal extrusions [9a/9b and 10a/10b] between vertical assemblies [3/4 and 5/6].
- 5) Attach support leg extrusions [11 and 12] to back of verticals [1 and 5], see leg attachment detail.
- 6) Attach monitor mount to upper vertical [4].

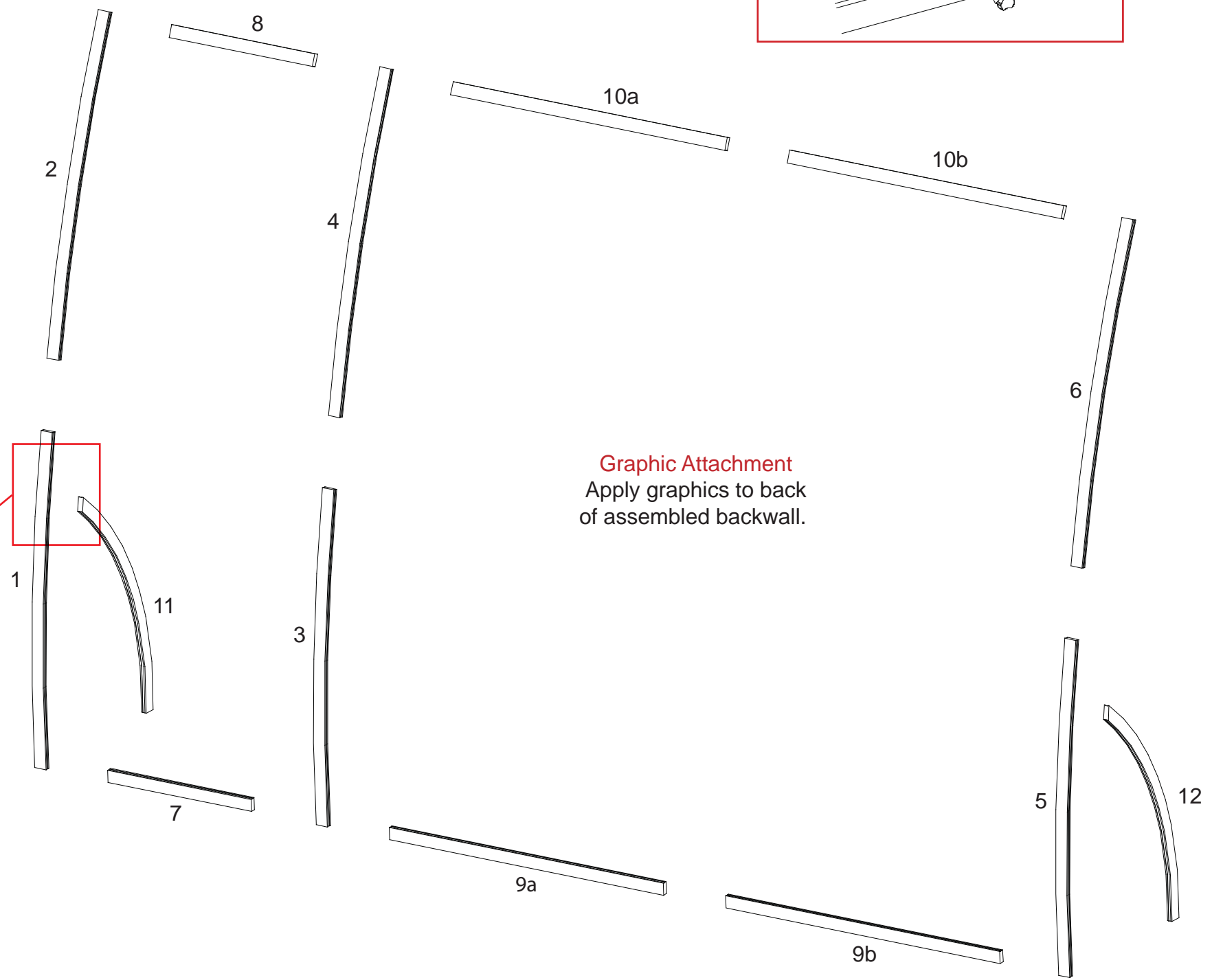

Graphic Attachment
Apply graphics to back of assembled backwall.

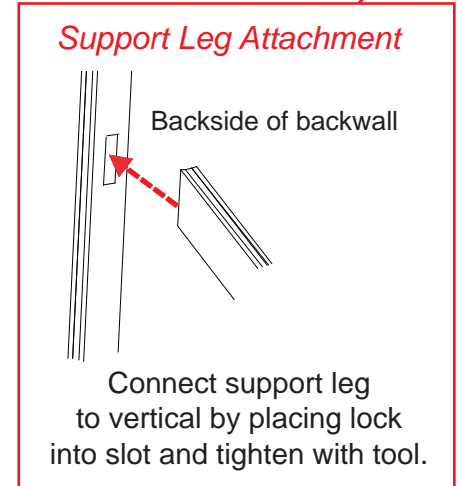
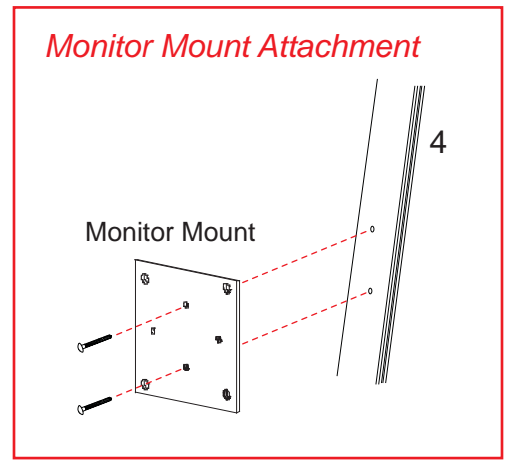

WHEN DISASSEMBLING ALUMINUM EXTRUSION, TIGHTEN ALL SETSCREWS AND LOCKS TO PREVENT LOSS DURING SHIPPING

866.652.2100

Part Number	Qty	Description
13	1	48.5" h Lower Curved Extrusion
14	1	48.5" h Upper Curved Extrusion
15	1	48.5" h Lower Curved Extrusion
16	1	48.5" h Upper Curved Extrusion
17a/17b	1/1	44" w Horizontal Extrusion
18a/18b	1/1	44" w Horizontal Extrusion
19	1	23" w Horizontal Extrusion
20	1	23" w Horizontal Extrusion
21	1	Backwall Support Leg Extrusion

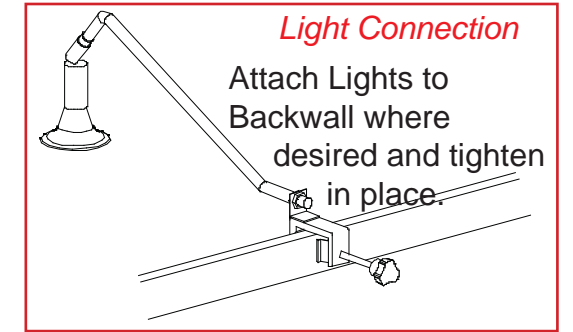

Steps

- 1) Connect backwall upper and lower verticals together [13 to 14 and 15 to 16].
- 2) Connect horizontal extrusions together [17a to 17b and 18a to 18b].
- 3) Attach horizontal assemblies [17a/17b and 18a/18b] between vertical assemblies [5/6 and 13/14].
- 4) Attach horizontal extrusions [19 and 20] between vertical assemblies [13/14 and 15/16].
- 5) Attach support leg extrusions [21] to back of verticals [15], see leg attachment detail.
- 6) Attach monitor mount to upper vertical [14].

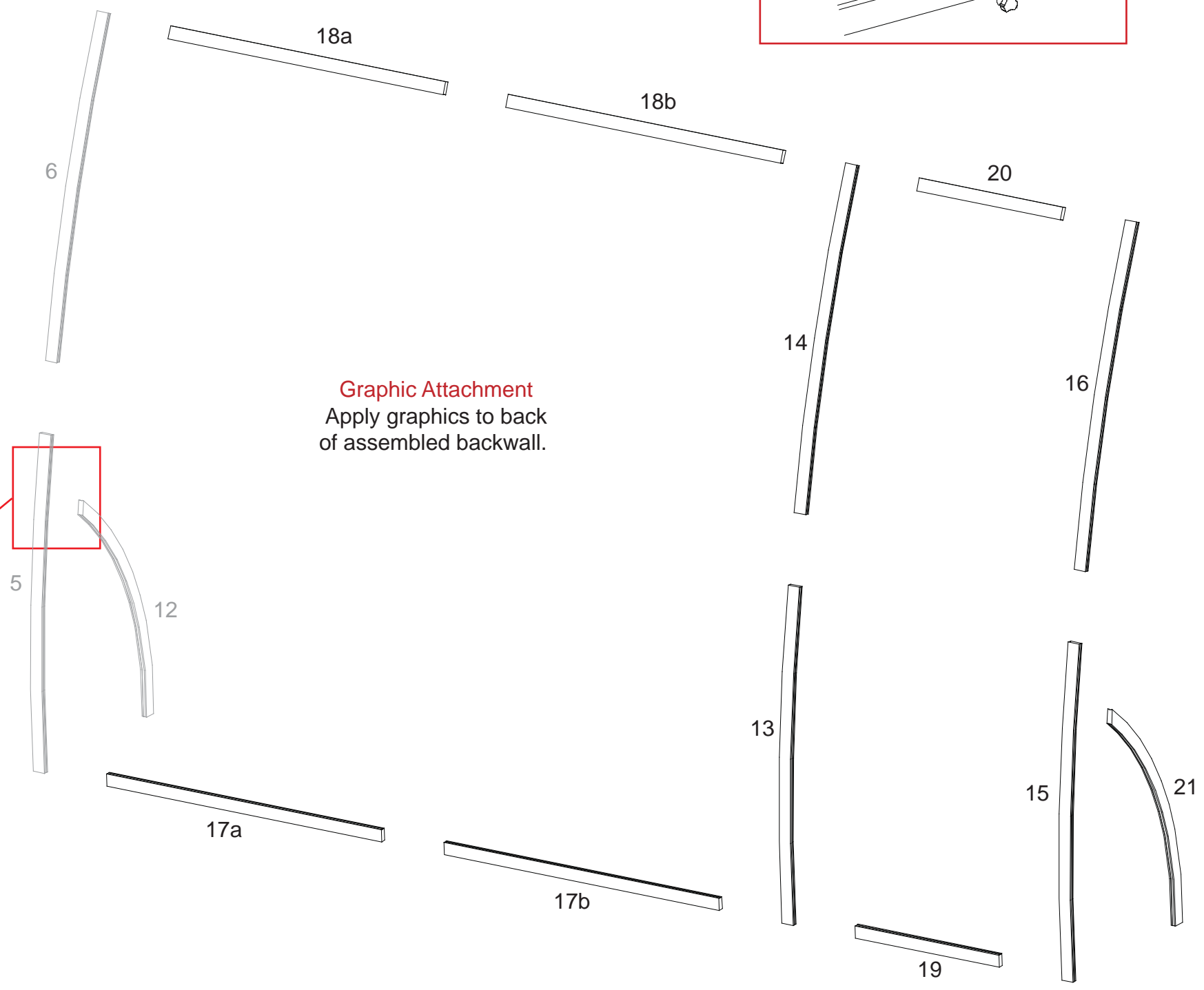

Graphic Attachment
Apply graphics to back of assembled backwall.

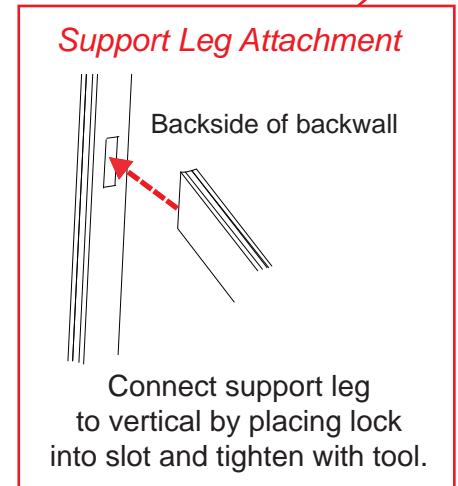
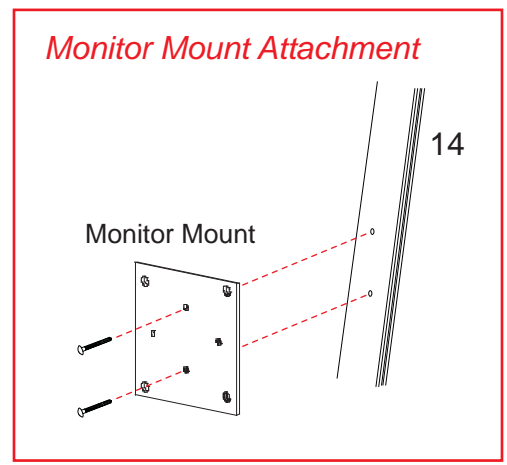

WHEN DISASSEMBLING ALUMINUM EXTRUSION, TIGHTEN ALL SETSCREWS AND LOCKS TO PREVENT LOSS DURING SHIPPING

866.652.2100

Part Number	Qty	Description
22	2	Base Plate
23	2	37.6" h Curved Vertical Extrusion
23a	2	Oval Flange Plate
24	2	18.5" w Horizontal Extrusion
25	2	15.69" w Horizontal Extrusion

Steps

- 1) Attach curved vertical [23] to base plate [22], see Base Plate Attachment detail.
- 2) Attach horizontal extrusions [24 and 25] between curved verticals [23] and backwall verticals [3 and 13] where indicated.
- 3) Attach flange plate to top of verticals [23] as shown.
- 4) Place counter tops on assembled counter base, see Counter Attachment detail.

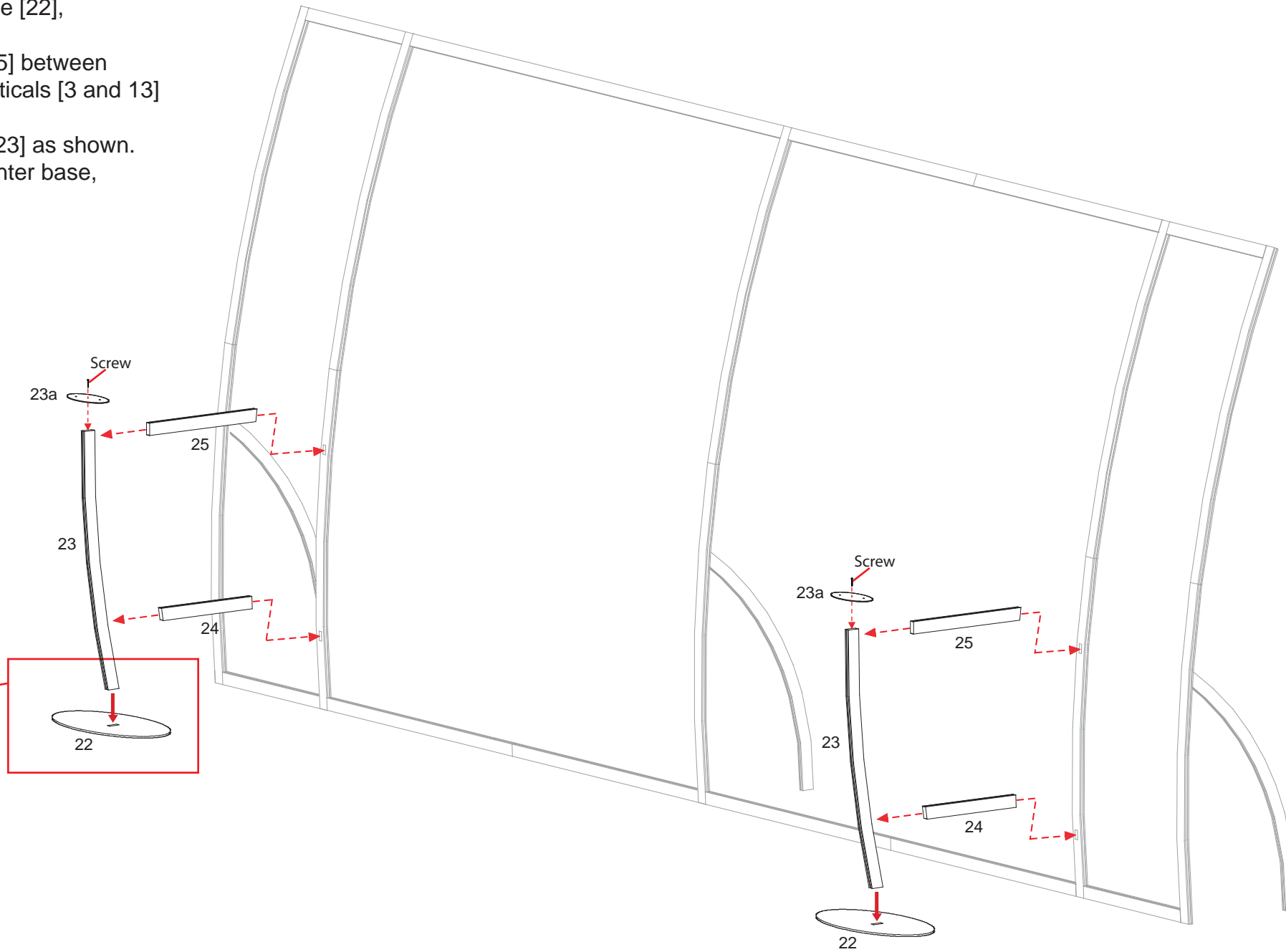

Base Plate Attachment

Connect Vertical Extrusion to Base Plate by placing lock into slot and tighten with tool.

Counter Top Attachment

Insert screws located on underside of counter into holes on flange plate and secure with wing nuts.

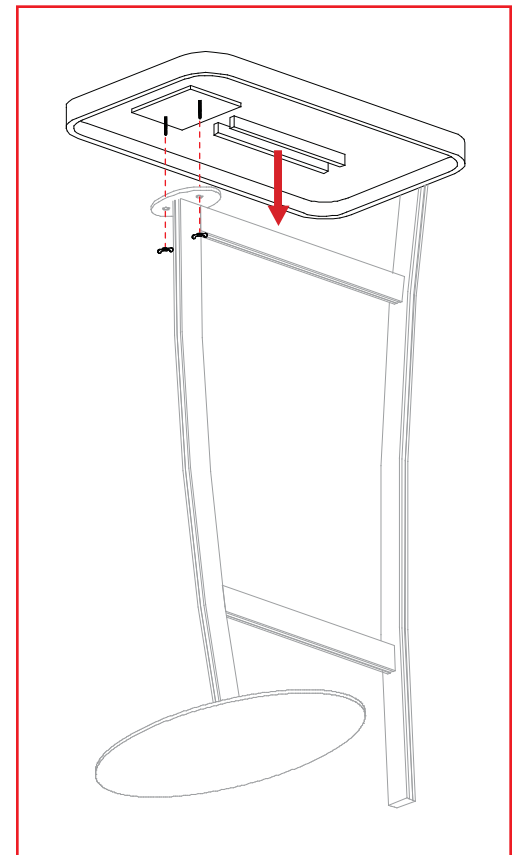

WHEN DISASSEMBLING ALUMINUM EXTRUSION, TIGHTEN ALL SETSCREWS AND LOCKS TO PREVENT LOSS DURING SHIPPING